

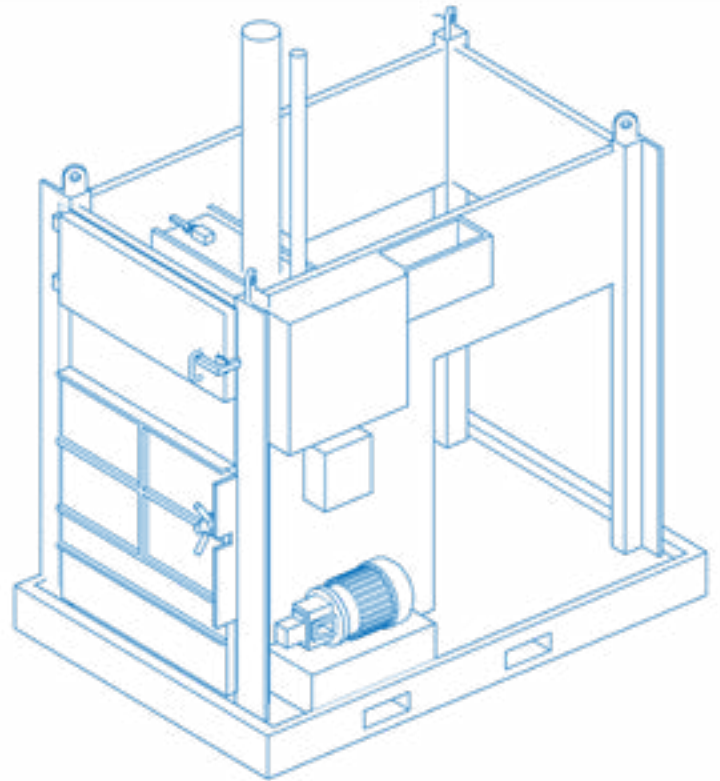

Waste Management

Specialized equipment for the safe transportation and recycling of waste streams in a marine or industrial environment



A waste solution for every challenge

Together, we forge the path to a brighter, safer and sustainable tomorrow.

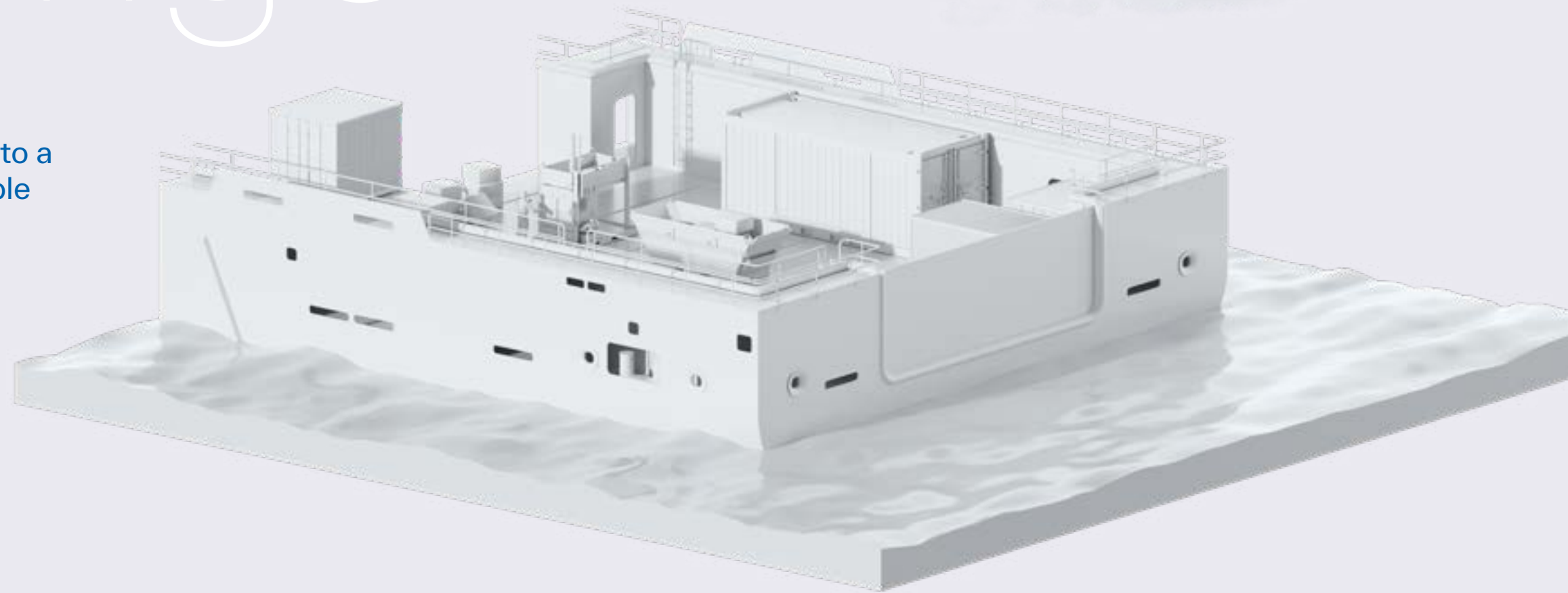

Our range of
integrated
solutions makes
us your go-to
to solve your
challenges in
waste disposal.

Waste Compactors



4000HM Waste Compactors

Model 4000HM



C-Series Compactors

Model 3000C
Model 4000C
Model 5000C



H-Series Compactors

Model H2
Model H5
Model H10
Model H15



CC Series Compactors

Model 3000CC
Model 4000CC



Marine Green Series Compactors

Model MG2
Model MG5
Model MG10
Model MG15



Recycling Compactors

Model R44
Model R6
Model R6x2



20M / 40M Compactors

Model 20M
Model 40M



Rollback Series Compactors

Model 3000RB
Model 4000RB
Model 5000RB

Balers



B36 Balers

Model B36



Stainless Steel Vertical Balers

Model H2
Model H5
Model H10
Model H15

Grinders



Stainless Steel Food Grinders

Model SO5ES



Tuff Gut Food Grinders



Tuff Gut II Food Grinders

5 Gallon Sink
45 Gallon Sink

Crushers



Glass Bottle Crushers



Can & Plastic Densifier Crushers

Model CG10



Drum Crushers

Model MPC40
Model MPC60
Model MPC85



Filter Crushers

Model FC3524
Model FC3536
Model FC5544

Compactor Bags



30% Recycled Compactor Bags



Regulated Waste Bags



Enviro-Pak® Offshore Waste Handling Solutions



Together, we are powering an energized, limitless future.

Who we are

Eliminate refuse safely, compliantly, and cost-effectively with the OEG Enviro-Pak® range of volume-reduction technologies.

The innovative, patented equipment is the result of decades of experience in refuse disposal, including industry-leading volunteer efforts such as the EPA award-winning Recycle the Gulf® program.

Around the world, we provide offshore and shore-based industries with high-quality products and an unmatched dedication to refuse disposal and recycling.

Our range of integrated solutions makes us your go-to to solve your challenges in waste handling and recycling equipment.

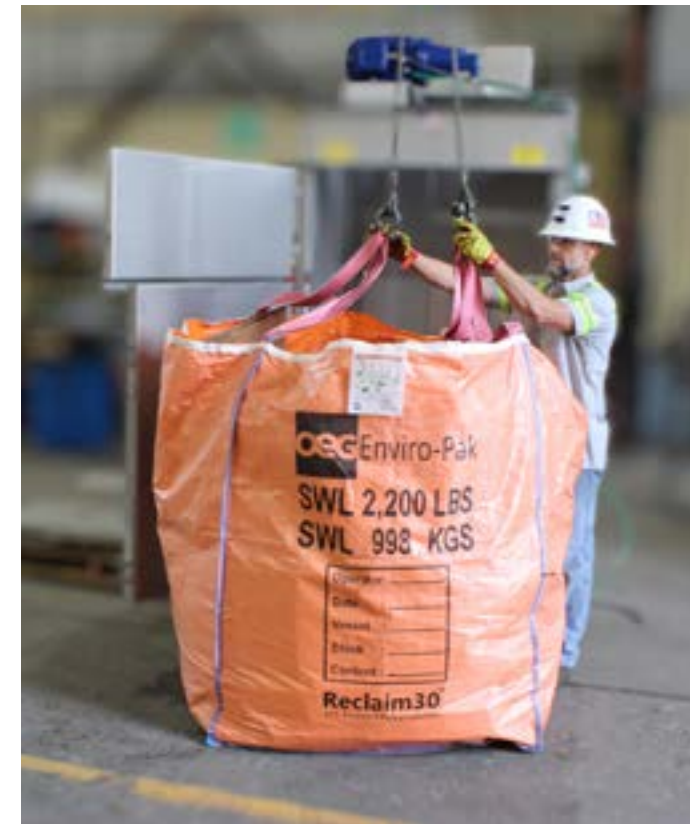

OEG Enviro-Pak's 4000HM Waste Compactor: A Smart Solution for Medical Waste Management

Medical waste is a serious environmental and health hazard that requires proper disposal and treatment. That's why OEG Enviro-Pak has developed the 4000 Hazardous Medical (HM) Waste Compactor, a state-of-the-art unit that can handle any type of medical waste with ease and safety.

The 4000HM Waste Compactor is designed to compress medical waste into compact pales that can fit into UN hazardous waste transportation boxes. Unlike other compactors, the 4000HM can achieve a remarkable compaction ratio of 88 pales per box, which is almost five times higher than the average compactor. This means that you can reduce the number of boxes needed for your waste by 80%, saving you a lot of space, time, and money.

One of our satisfied customers, a manufacturer located in the US, reported that they saved \$1,000,000 USD in waste transportation costs in the first year of using the 4000HM Waste Compactor. They also praised the machine's performance, reliability, and ease of use.

The 4000HM Waste Compactor also features a HEPA/HEGA system that filters out any toxic fumes and dust that may be generated during the compaction process. This ensures that the machine operates in a clean and safe manner, protecting the health of your staff and the environment.

OEG Enviro-Pak's 4000HM Waste Compactor can help you reduce your waste volume, transportation costs, and environmental impact.

4000HM Waste Compactors

The 4000HM Waste Compactors compact hazardous waste inside UN/DOT approved 1 cubic yard corrugated disposable shipping containers with up to 60,000 pounds of compaction force.

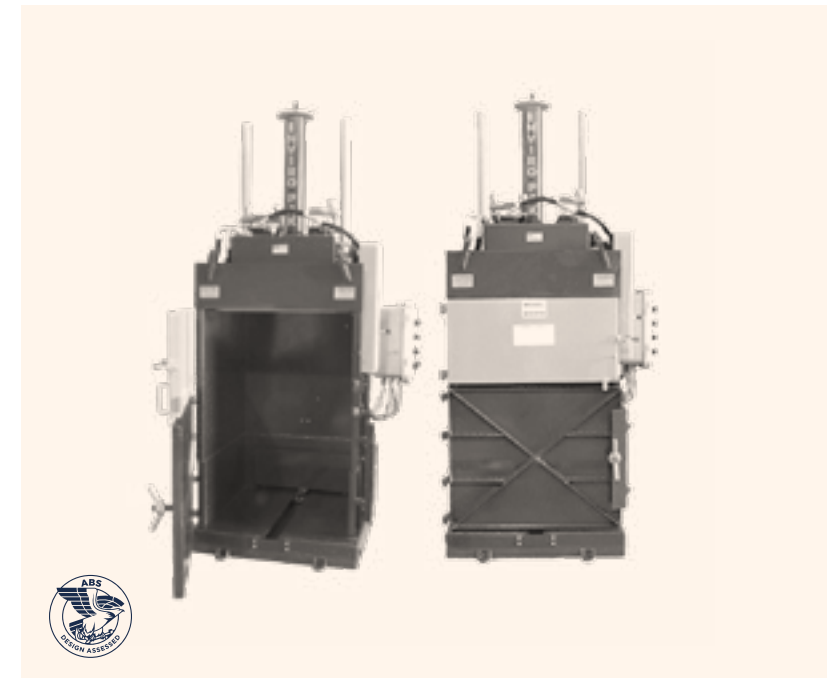

KEY FEATURES

- COMPACTION FORCE IS TRANSFERRED DIRECTLY TO THE COMPACTOR WALLS, ELIMINATING DISTORTION OF THE CONTAINER
- AUTOMATIC COMPACTOR OPERATION, MANUALLY CONTROLLED HYDRAULIC CONTAINER EJECT FUNCTION
- 1000 POUNDS OR 2000 POUNDS CAPACITY SHIPPING CONTAINERS, POLY LINERS AVAILABLE
- OPTIONAL HEPA FILTRATIONS SYSTEM AVAILABLE
- REDUCE DISPOSAL COSTS UP TO 90% BY COMPACTING HAZARDOUS WASTES
- UV LIGHT FOR SANITATION

UNIT	MODEL 4000HM
Capacity	27 ft ³ / 0.76 m ³
Height	117" / 2971 mm
Width	51" / 1295 mm
Depth	53" / 1321 mm
Deck Space	18 ft ² / 1.7 m ²
Weight	3,500 lbs / 1588 kg
Compaction Force	60,000 lbs / 27216 kg
Electrical Rating	5HP 230/460V 15.5/7.8 AMPS
Air Requirement	100PSI / 175CFM
Cycle Time	95 seconds
Oil Capacity	10 GAL / 38 L

Note: All measurements are rounded up to the nearest whole unit or decimal.

C-Series Compactors

OEG Enviro-Pak's C-Series Compactors are designed to function as both a compactor and a baler, featuring a hydraulic operated roll back top for easy loading and unloading. The C-Series Compactors compact all types of non-hazardous waste into the compactor bag.

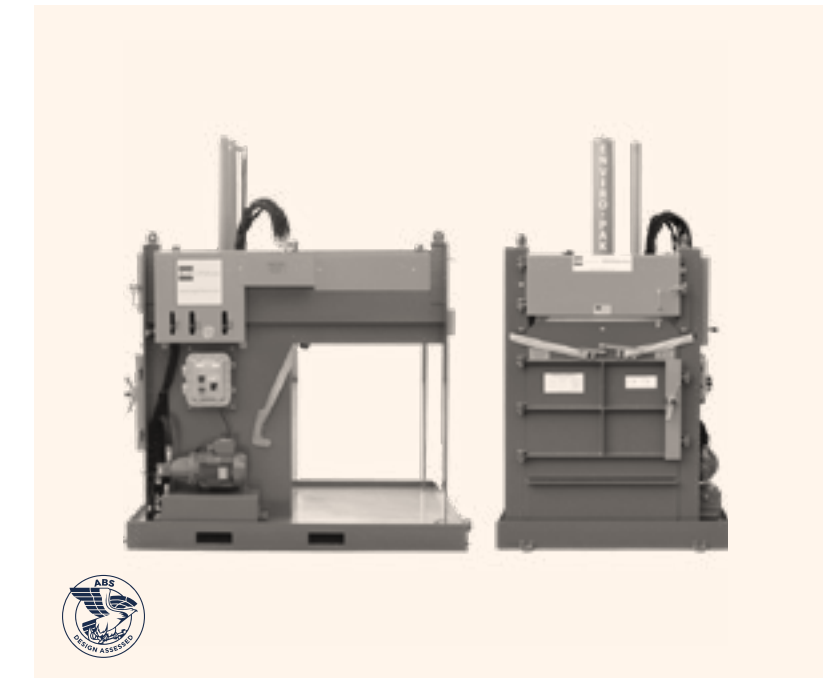

KEY FEATURES

- MOVING PARTS COMPLETELY ENCLOSED TO PREVENT INJURY
- IN BAG COMPACTION AT A 5:1 SAFETY RATIO
- SLOW RELEASE DOOR FOR EASY BAG REMOVAL
- TWO HAND OPERATION FOR OPERATOR SAFETY
- FILTER/CAN/GLASS CRUSHER AND FOOD GRIND ATTACHMENT AVAILABLE
- REDUCE DISPOSAL COSTS BY REDUCING WASTE VOLUME
- UL LISTED COMPONENTS
- MEETS AND EXCEEDS INTERNATIONAL MARPOL 73/78 ANNEX V
- PATENTED
- UV LIGHT FOR SANITATION

UNIT	MODEL 3000C	MODEL 4000C	MODEL 5000C
Capacity	30 ft ³ / 0.9 m ³	40 ft ³ / 1.1 m ³	50 ft ³ / 1.42 m ³
Height	107" / 2718 mm	107" / 2718 mm	114" / 2896 mm
Width	56" / 1422 mm	62" / 1575 mm	62" / 1575 mm
Depth	83" / 2108 mm	92" / 2336 mm	95" / 2413 mm
Deck Space	32 ft ² / 3.0 m ²	38 ft ² / 3.5 m ²	38 ft ² / 3.5 m ²
Weight	3,900 lbs / 1772 kg	4,115 lbs / 1867 kg	4,360 lbs / 1982 kg
Compaction Force	60,000 lbs / 27216 kg	60,000 lbs / 27216 kg	60,000 lbs / 27216 kg
Bag Model	HV96026	HV96030	HV96027
Bag SWL	1,500 lbs / 680 kg	2,200 lbs / 997 kg	2,200 lbs / 997 kg
Electrical Rating	5HP 230/460V 15.5/7.8 AMP	5HP 230/460V 15.5/7.8 AMP	5HP 230/460V 15.5/7.8 AMP
Air Requirement	100PSI / 175CFM	100PSI / 175CFM	100PSI / 175CFM
Cycle Time	96 seconds	96 seconds	96 seconds
Oil Capacity	10 GAL / 38 L	10 GAL / 38 L	10 GAL / 38 L

Note: All measurements are rounded up to the nearest whole unit or decimal.

H-Series Compactors

OEG Enviro-Pak's H-Series Compactors are designed to compact all types of non-hazardous waste and can be modified to process medical waste. The compactors improve shipboard incinerator efficiency and reduce operating time by compacting waste prior to incineration.

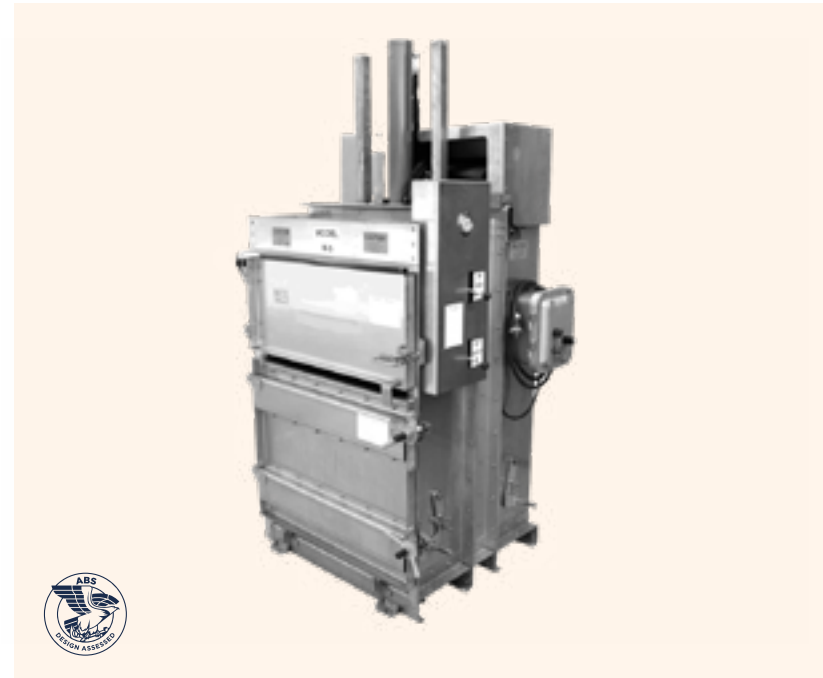

KEY FEATURES

- 100% STAINLESS STEEL STRUCTURE
- COMPONENT PARTS ARE SAND BLASTED AND PAINTED
- DOOR WITH LATCH ENGINEERED FOR GRADUAL RELEASE
- BAGS MANUFACTURED TO A 5:1 SAFETY RATIO
- AIR OR ELECTRIC OPERATION
- TWO HAND OPERATION FOR OPERATOR SAFETY
- SAFETY SWITCH ON DOOR PREVENTS OPERATION
- MANUAL OPERATION IS STANDARD
- BALING CAPABILITIES AVAILABLE UPON REQUEST
- UL LISTED COMPONENTS
- MEETS AND EXCEEDS INTERNATIONAL MARPOL 73/78 ANNEX V
- PATENTED
- UV LIGHT FOR SANITATION

UNIT	MODEL H2	MODEL H5	MODEL H10	MODEL H15
Capacity	6 ft ³ / 0.2 m ³	20 ft ³ / 0.57 m ³	40 ft ³ / 1.1 m ³	50 ft ³ / 1.4 m ³
Height	79" / 2006 mm	90" / 2286 mm	120" / 3048 mm	128" / 3251 mm
Width	32" / 813 mm	46" / 1168 mm	49" / 1245 mm	52" / 1320 mm
Depth	27" / 686 mm	48" / 1219 mm	55" / 1397 mm	58" / 1473 mm
Deck Space	6 ft ² / 0.6 m ²	15 ft ² / 1.4 m ²	19 ft ² / 1.8 m ²	21 ft ² / 2.0 m ²
Weight	520 lbs / 236 kg	1,615 lbs / 733 kg	1,930 lbs / 876 kg	2,100 lbs / 952 kg
Compaction Force	10,000 lbs / 4536 kg	28,000 lbs / 12701 kg	40,000 lbs / 18144 kg	40,000 lbs / 18144 kg
Bag Model	HV96033	HV96025	HV96030	HV96027
Bag SWL	650 lbs / 295 kg	1000 lbs / 454 kg	2,200 lbs / 997 kg	2,200 lbs / 997 kg
Electrical Rating	2HP 110/230/480V 14/5.8/2.9 AMPS	3HP 230/460V 7.8/2.9 AMPS	3HP 230/460V 7.8/2.9 AMPS	3HP 230/460V 7.8/2.9 AMPS
Air Requirement	100PSI / 175 CFM	100PSI / 175 CFM	100PSI / 175 CFM	100PSI / 175 CFM
Cycle Time	35 seconds	50 seconds	95 seconds	95 seconds
Oil Capacity	1.5 GAL / 5.6 L	2.5 GAL / 9.5 L	10 GAL / 38 L	10 GAL / 38 L

Note: All measurements are rounded up to the nearest whole unit or decimal.

Marine Green Series Compactors

The Marine Green Series Compactors segregate and compact solid waste materials into wheeled carts for recycling and convenience. The design means that no ramps are needed for placement and removal of carts and there is no compaction force on the wheels.

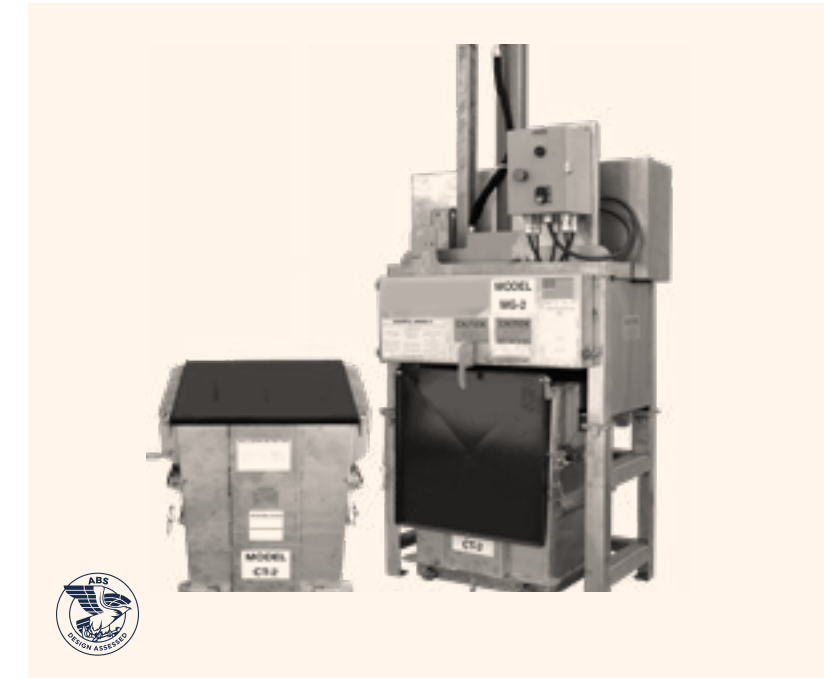

KEY FEATURES

- ENCLOSED STRUCTURE FOR COMPACTION OPERATIONS
- POSITIVE LOCK-IN RESTRAINT SYSTEM SECURES CART INTO COMPACTOR OR TO BULKHEAD
- CART DOOR WITH LATCH ENGINEERED FOR GRADUAL RELEASE
- BAGS MANUFACTURED TO A 5:1 SAFETY RATIO
- MEETS AND EXCEEDS INTERNATIONAL MARPOL 73/78 ANNEX V
- PATENT PENDING
- UV LIGHT FOR SANITATION

UNIT	MODEL MG2	MODEL MG5	MODEL MG10	MODEL MG15
Capacity	7 ft ³ / 0.2 m ³	19 ft ³ / 0.52 m ³	45 ft ³ / 1.2 m ³	58 ft ³ / 1.6 m ³
Height	76" / 1930 mm 28" / 711 mm	89" / 2261 mm 43" / 1092 mm	107" / 2718 mm 56" / 1422 mm	120" / 3048 mm 60" / 1524 mm
Width	32" / 813 mm 25" / 635 mm	43" / 1092 mm 40" / 1016 mm	54" / 1372 mm 48" / 1219 mm	57" / 1448 mm 46" / 1168 mm
Depth	24" / 610 mm 22" / 559 mm	44" / 1118 mm 43" / 1092 mm	46" / 1168 mm 44" / 1118 mm	49" / 1245 mm 47" / 1194 mm
Deck Space	6 ft ² / 0.6 m ² 4 ft ² / 0.4 m ²	13 ft ² / 1.2 m ² 11.6 ft ² / 1.1 m ²	17 ft ² / 1.6 m ² 14 ft ² / 1.3 m ²	19 ft ² / 1.8 m ² 15 ft ² / 1.4 m ²
Weight	435 lbs / 198 kg 86 lbs / 39 kg	800 lbs / 363 kg 250 lbs / 113kg	940 lbs / 426 kg 450 lbs / 204 kg	1,100 lbs / 499 kg 500 lbs / 227 kg
Compaction Force	10,000 lbs / 4536 kg	10,000 lbs / 4536 kg	30,000 lbs / 13608 kg	30,000 lbs / 13608 kg
Bag Model	HV96033	HV96024	HV96030	HV96027
Bag SWL	650 lbs / 295 kg	600 lbs / 272 kg	2,200 lbs / 997 kg	2,200 lbs / 997 kg
Electrical Rating	2HP 110/230/460V 14/5.8/2.9 AMPS	2HP 110/230/460V 14/5.8/2.9 AMPS	3HP 230/460V 7.8/3.9 AMPS	3HP 230/460V 7.8/3.9 AMPS
Air Requirement	100PSI / 125CFM	100PSI / 125CFM	100PSI / 125CFM	100PSI / 125CFM
Cycle Time	35 seconds	35 seconds	80 seconds	80 seconds
Oil Capacity	1.5 GAL / 5.6 L	1.5 GAL / 5.6 L	2.5 GAL / 9.5 L	2.5 GAL / 9.5 L

Note: All measurements are rounded up to the nearest whole unit or decimal.

Rollback Series Compactors

KEY FEATURES

- SIMPLE, SAFE, RELIABLE OPERATION
- MOVING PARTS COMPLETELY ENCLOSED TO PREVENT INJURY
- HYDRAULICALLY OPERATED ROLL BACK TOP FOR EASY LOADING AND UNLOADING
- COMPACTS ALL TYPES OF NON-HAZARDOUS WASTE INTO BAG
- IN BAG COMPACTION AT A 5:1 SAFETY RATIO
- SLOW RELEASE DOOR FOR EASY BAG REMOVAL
- AIR OR ELECTRIC OPERATION
- DRUM CRUSHING IN CHAMBER WITH NO ADAPTOR
- DEEP DRIP PAN WITH 2 INCH WELDED DRAIN PLUG
- OPTIONAL FOOD GRINDER ATTACHMENT OR FILTER CRUSHER AVAILABLE

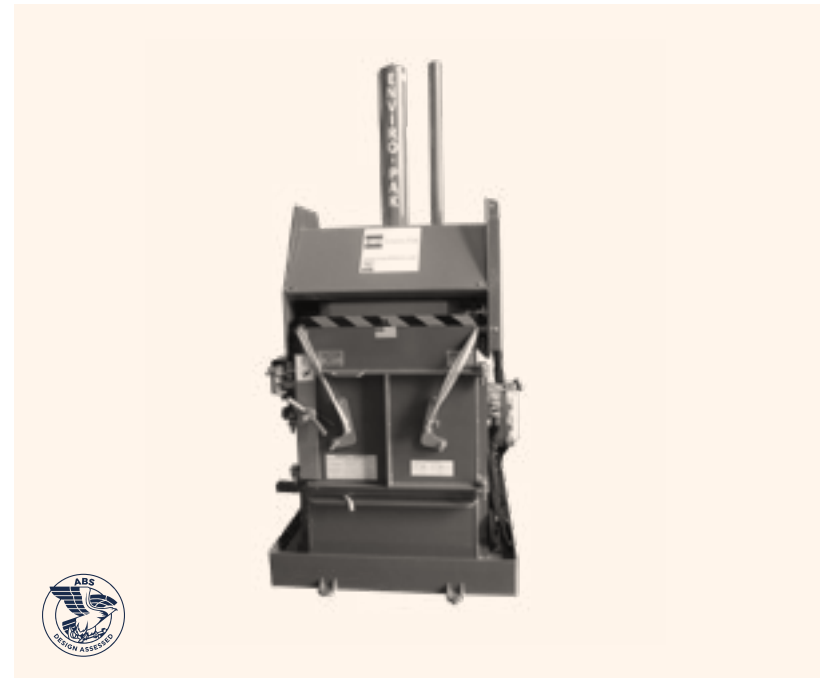

UNIT	MODEL 3000RB	MODEL 4000RB	MODEL 5000RB
Capacity	30 ft ³ / 0.85 m ³	40 ft ³ / 1.14 m ³	50 ft ³ / 1.42 m ³
Height	113" / 2692 mm	113" / 2871 mm	111" / 2820 mm
Width	51-1/8" / 1299 mm	60" / 1524 mm	62" / 1575 mm
Depth	92" / 2337 mm	91" / 2312 mm	93" / 2337 mm
Deck Space	31 ft ² / 2.88 m ²	35 ft ² / 3.25 m ²	35 ft ² / 3.25 m ²
Weight	3030 lbs / 1377 kg	3800 lbs / 1724 kg	4010 lbs / 1822 kg
Compaction Force	60,000 lbs / 30 t	60,000 lbs / 30 t	60,000 lbs / 30 t
Electrical Rating	5HP 15.5/7.8 AMPS	5HP 15.5/7.8 AMPS	5HP 15.5/7.8 AMPS
Air Requirement	100PSI / 175CFM	100PSI / 175CFM	100PSI / 175CFM
Cycle Time	60 seconds	60 seconds	60 seconds

Note: All measurements are rounded up to the nearest whole unit or decimal.

CC-Series Compactors

KEY FEATURES

- SIMPLE, SAFE, RELIABLE OPERATION
- INTERLOCK DOOR WITH DOOR LATCH ENGINEERED FOR GRADUAL RELEASE
- SEAL WELDED FOR STRENGTH AND CORROSION PROTECTION
- FUNCTIONS AS BOTH A COMPACTOR AND A BALER
- MOVING PARTS COMPLETELY ENCLOSED TO PREVENT INJURY
- HYDRAULIC OPERATED ROLL BACK TOP FOR EASY LOADING AND UNLOADING
- IN BAG COMPACTION AT A 5:1 SAFETY RATIO
- REDUCE DISPOSAL COSTS BY REDUCING WASTE VOLUME
- FILTER/CAN/GLASS CRUSHER, FOOD GRINDER, AND SHREDDER ATTACHMENT AVAILABLE
- MEETS AND EXCEEDS INTERNATIONAL MARPOL 73/78 ANNEX V



UNIT	MODEL 3000CC	MODEL 4000CC
Capacity	30 ft ³	40 ft ³
Height	107-1/8" / 2721.37 mm	107-1/4" / 2724 mm
Width	56" / 1422 mm	62" / 1575 mm
Depth	83" / 2108 mm	91" / 2312 mm
Deck Space	32 ft ² / 2.97 m ²	39 ft ² / 3.6 m ²
Weight	4450 lbs / 2018 kg	4750 lbs / 2159 kg
Compaction Force	60,000 lbs / 30 t	60,000 lbs / 30 t
Electrical Rating	5HP 15.5/7.8 AMP	5HP 15.5/7.8 AMP
Air Requirement	100PSI / 175CFM	100PSI / 175CFM
Cycle Time	90 seconds	90 seconds

Note: All measurements are rounded up to the nearest whole unit or decimal.

20M / 40M Waste Compactors

KEY FEATURES

- SIMPLE, SAFE, RELIABLE OPERATION
- DOOR WITH LATCH ENGINEERED FOR GRADUAL RELEASE
- LARGE LOAD DOOR, 34 INCHES X 24 INCHES
- TOTALLY ENCLOSED DRIP PAN
- HOSES RATED TO 16,000 PSI
- RELIEF VALVE ON HYDRAULIC SYSTEM
- HYDRAULIC BAG PUSH OUT SYSTEM FOR EASY REMOVAL
- SEAL WELDED FOR STRENGTH AND CORROSION PROTECTION
- SAND BLASTED TO WHITE METAL AND ZINC COATED - EPOXY TOP COAT
- IN BAG (WOVEN POLYPROPYLENE) COMPACTION WITH A 5:1 SAFETY RATIO
- COMPACTS ALL TYPES OF WASTE

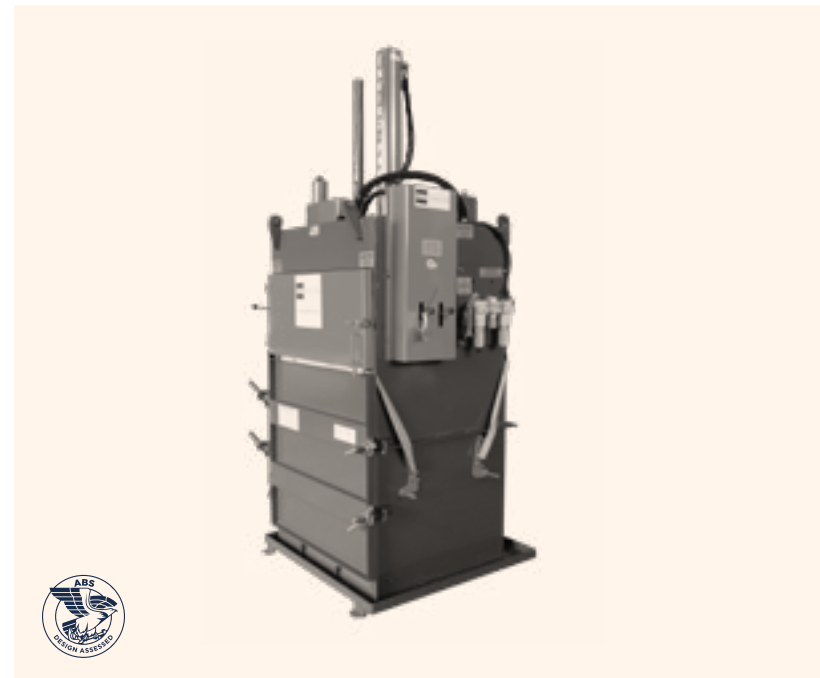

UNIT	MODEL 20M	MODEL 40M
Capacity	20 ft ³ / 0.57 m ³	40 ft ³ / 1.14 m ³
Height	90" / 2286 mm	118" / 2997 mm
Width	39" / 991 mm	56" / 1423 mm
Depth	43" / 1093 mm	52" / 1321 mm
Deck Space	12 ft ² / 1.12 m ²	18 ft ² / 1.68 m ²
Weight	2320 lbs / 1053 kg	2450 lbs / 1112 kg
Compaction Force	28,000 lbs / 14 t	40,000 lbs / 20 t
Electrical Rating	5HP 15.5/7.8 AMPS	5HP 15.5/7.8 AMPS
Air Requirement	100PSI / 75CFM	100PSI / 75CFM
Cycle Time	35 seconds	45 seconds

Note: All measurements are rounded up to the nearest whole unit or decimal.

600CB Waste Compactors

KEY FEATURES

- SIMPLE, SAFE, RELIABLE OPERATION
- CAN BE CONVERTED TO A TRASH COMPACTOR
- DOOR WITH LATCH ENGINEERED FOR GRADUAL RELEASE
- SEAL WELDED FOR STRENGTH AND CORROSION PROTECTION
- IN BAG COMPACTION WITH A 5:1 SAFETY RATIO
- COMPACTS ALL TYPES OF WASTE



UNIT	600CB
Capacity	6 ft ³
Height	87" / 2203 mm
Width	27" / 669 mm
Depth	24" / 614 mm
Deck Space	5 ft ² / 0.46 m ²
Weight	750 lbs / 341 kg
Compaction Force	14,700 lbs
Electrical Rating	2HP 14, 5.8, 2.9 AMPS
Air Requirement	100 PSI / 128 CFM
Cycle Time	26 seconds

Note: All measurements are rounded up to the nearest whole unit or decimal.

Recycling Compactors

OEG Enviro-Pak's Recycling Compactors compact recyclable solid waste materials into disposable bags. Recyclable materials such as aluminium, paper, cardboard, tin and PETE plastics are separated at the source and compacted.

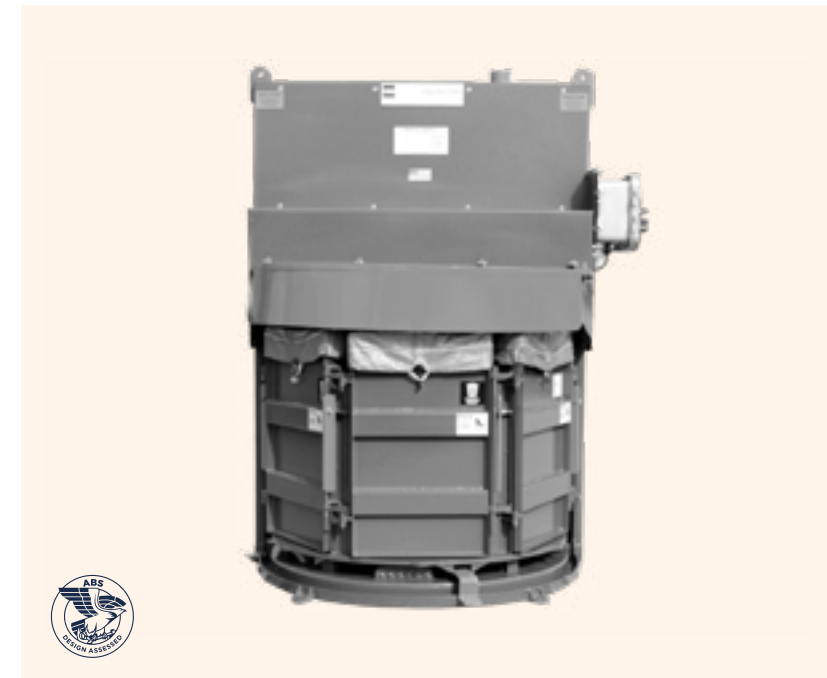

KEY FEATURES

- UTILIZING MULTIPLE COMPACTION CHAMBERS ON A ROTATING TABLE
- SMALL FOOTPRINT ENCLOSED WITH DRIP PAN AND DRAIN PLUGS
- IN BAG (WOVEN POLYPROPYLENE) COMPACTION WITH A 5:1 SAFETY RATIO
- TWO HAND OPERATION FOR OPERATOR SAFETY
- OPTIONAL FOOD GRINDER ATTACHMENT OR FILTER CRUSHER AVAILABLE
- UL LISTED COMPONENTS
- MEETS AND EXCEEDS INTERNATIONAL MARPOL 73/78 ANNEX V
- PATENTED
- UV LIGHT FOR SANITATION

UNIT	MODEL R44	MODEL R6	MODEL R6X2
Capacity	4 Chamber Carousel 4 x 4.5 ft ³ / 0.13 m ³	6 Chamber Carousel 6 x 5.5 ft ³ / 0.16 m ³	8 Chamber Carousel (6) 5.5 ft ³ / 0.16 m ³ (2) 14 ft ³ / 0.4 m ³
Height	90" / 2286 mm	95" / 2413 mm	126" / 3201 mm
Width	49" / 1245 mm	72" / 1829 mm	86" / 2184 mm
Depth	44" / 1118 mm	64" / 1626 mm	79" / 2006 mm
Deck Space	15 ft ² / 1.4 m ²	32 ft ² / 3.0 m ²	49 ft ² / 4.6 m ²
Weight	1,860 lbs / 843 kg	3,500 lbs / 1588 kg	5,900 lbs / 2677 kg
Compaction Force	16,000 lbs / 7620 kg	29,000 lbs / 13154 kg	38,000 lbs / 13154 kg
Bag Model	HV96034	HV96035	HV96022 (2) HV96035 (6)
Bag SWL	350 lbs / 159 kg	600 lbs / 272 kg	550 lbs / 250 kg
Electrical Rating	5HP 230/460V 7.8/15.5 AMP	5HP 230/460V 7.8/15.5 AMP	5HP 230/460V 7.8/15.5 AMP
Air Requirement	100PSI / 175 CFM	100PSI / 175 CFM	100PSI / 175 CFM
Cycle Time	30 seconds	30 seconds	30 / 66 seconds
Oil Capacity	4 GAL / 15 L	7 GAL / 26.5 L	11 GAL / 42.3 L

Note: All measurements are rounded up to the nearest whole unit or decimal.

Drum Crushers

OEG Enviro-Pak's Drum Crushers compact waste into 55/85 gallon drums before crushing the waste further. The Drum Crushers can crush 55 gallon drums to 4" and reduce disposal costs of hazardous waste by compacting into UN/DOT approved drums.

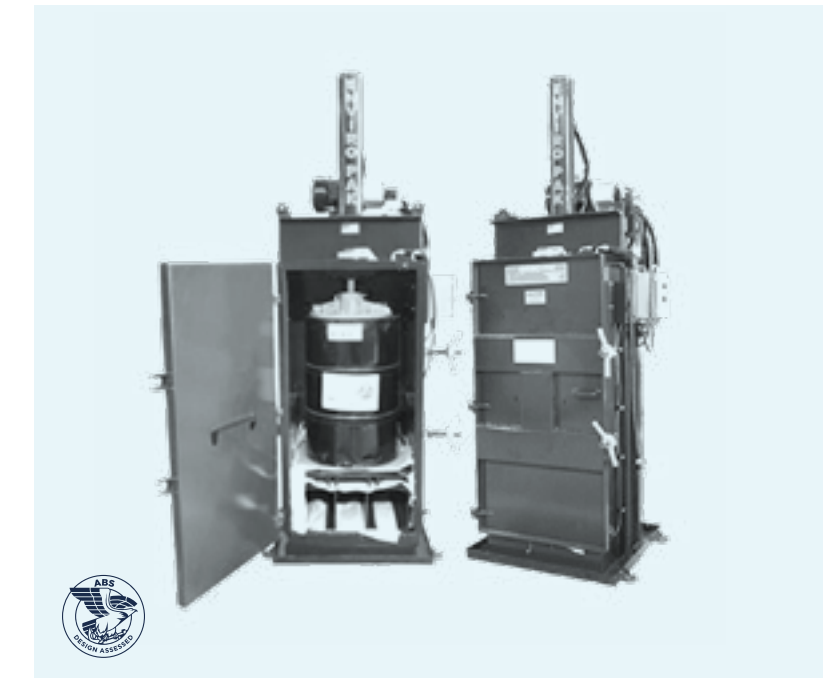

KEY FEATURES

- ANVIL SUPPORT BASE TO ENSURE DRUM INTEGRITY
- SAFETY LIMIT SWITCH ON DOOR
- HEPA FILTRATION AVAILABLE
- DRIP PAN AVAILABLE
- DRUM HANDLING PALLET INCLUDED
- DRUM CRUSHING PALLET INCLUDED
- TWO HAND OPERATION FOR OPERATOR SAFETY
- AIR OR ELECTRIC OPERATIONS, EX-PROOF RATED AVAILABLE
- UL LISTED COMPONENTS
- MEETS AND EXCEEDS INTERNATIONAL MARPOL 73/78 ANNEX V
- UV LIGHT FOR SANITATION

UNIT	MODEL MPC40	MODEL MPC60	MODEL MPC85
Drum Size	55 gal. / 208 litres	55 gal. / 208 litres	85 gal. / 321 litres
Height	104" / 2641 mm	118" / 2997 mm	113" / 2870 mm
Width	39" / 990 mm	48" / 1219 mm	54" / 1372 mm
Depth	38" / 965 mm	39" / 990 mm	46" / 1168 mm
Deck Space	10 ft ² / 1.0 m ²	13 ft ² / 1.2 m ²	17 ft ² / 1.6 m ²
Weight	1,615 lbs / 733 kg	1,840 lbs / 835 kg	3,100 lbs / 1406 kg
Compaction Force	30,000 lbs / 13607 kg	60,000 lbs / 27215 kg	85,000 lbs / 38555 kg
Electrical Rating	3HP 230/460V 7.8 / 2.9 AMP	5HP 230/460V 15.5 / 7.8 AMP	10HP 230/460V 26.8 / 13.4 AMP
Air Requirement	100PSI / 175 CFM	100PSI / 175 CFM	100PSI / 175 CFM
Cycle Time	60 seconds	96 seconds	75 seconds
Oil Capacity	10 gal / 37.8 litres	10 gal / 37.8 litres	10 gal / 37.8 litres
In Drum Compaction	Yes	Yes	Yes
Drum Compaction	No	Yes	Yes

Note: All measurements are rounded up to the nearest whole unit or decimal.

Can & Plastic Densifier Crushers

OEG Enviro-Pak's Can & Plastic Densifier Crushers are capable of crushing 600 aluminium cans down to 0.4 ft³ / 14 litres, and can crush both aluminium and tin cans.

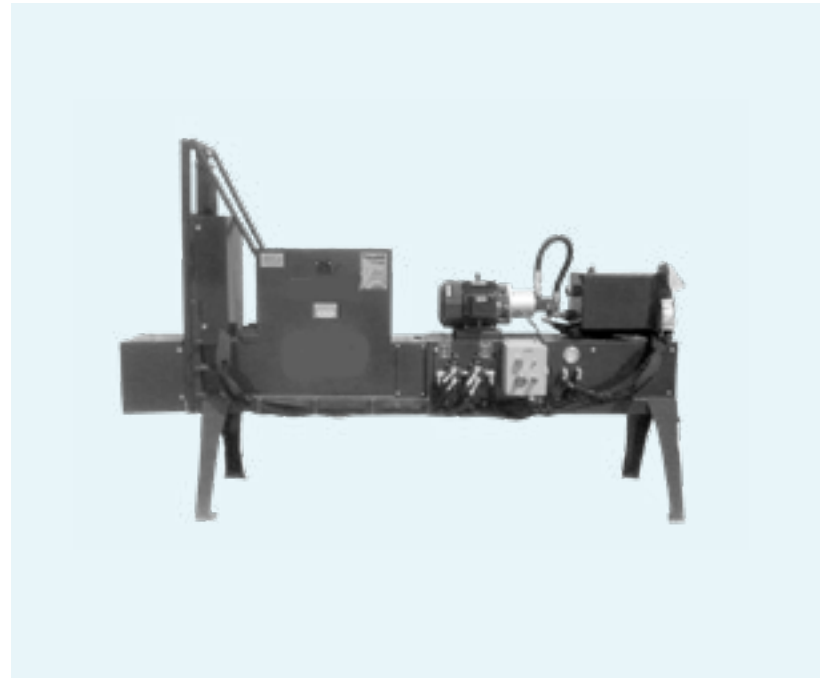

KEY FEATURES

- TOP-MOUNTED HOPPER FOR FEEDING CANS
- SAFETY SWITCH LOCATED ON THE HOPPER LID
- UL LISTED COMPONENTS
- MEETS AND EXCEEDS INTERNATIONAL MARPOL 73/78 ANNEX V
- AIR OR ELECTRIC
- AUTOMATIC COMPACTION / MANUAL EJECT VERSION AVAILABLE

UNIT	MODEL CG10
Capacity	4,000 cans/hr
Height	85" / 2159 mm
Width	120" / 3048 mm
Depth	30" / 762 mm
Deck Space	25 ft ² / 2.3 m ²
Weight	2,200 lbs / 998 kg
Compaction Force	60,000 lbs / 27215 kg
Oil Capacity	10 gal. / 37.8 litres
Electrical Rating	5HP / 7.5HP / 10HP
Air Requirement	100PSI / 75CFM
Cycle Time	96 / 72 / 58 seconds

Note: All measurements are rounded up to the nearest whole unit or decimal.

Glass Bottle Crushers

OEG Enviro-Pak's Glass Bottle Crushers are capable of crushing bottles as large as 750ml, with the capacity to crush up to 4 cases of 12 oz bottles into the bin.



KEY FEATURES

- STAINLESS STEEL CABINET
- HEAVY DUTY CRUSHER
- FOAM INSULATED CABINET TO REDUCE NOISE
- REDUCES GLASS TO RECYCLABLE CULLET
- HEAVY DUTY 1/2 HP MOTOR
- AUTOMATIC SHUT OFF WHEN GLASS BIN REACHES 35 POUNDS / 15.9 KG
- UP TO 80% VOLUME REDUCTION
- CRUSHES BOTTLES AS FAST AS CAN BE SAFELY FED, BIN MUST BE IN PLACE BEFORE UNIT WILL OPERATE

UNIT	GLASS BOTTLE CRUSHER
Capacity	up to 750 ml. bottle
Height	37"
Width	18.5"
Depth	19"
HP	1/2 HP
Power Supply	115 / 60 / 1 or 220 / 60 / 1

Note: All measurements are rounded up to the nearest whole unit or decimal.

Filter Crushers

KEY FEATURES

- REMOVES 95% OF FREE FLOWING OIL
- REDUCES DISPOSAL COSTS BY 90%
- CAPABLE OF CRUSHING PAINT CANS AND MORE
- AIR OR ELECTRIC OPERATING SYSTEMS, EX-PROOF AVAILABLE
- MEETS AND EXCEEDS INTERNATIONAL MARPOL 73/78 ANNEX V

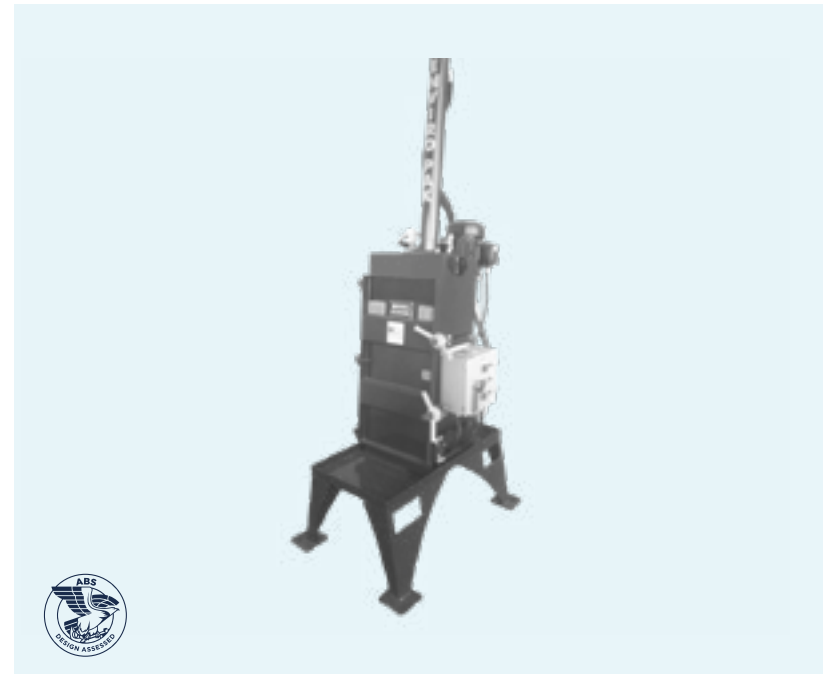

UNIT	MODEL FC3524	MODEL FC3536	MODEL FC5544
Filter Height Capacity	24" / 610 mm	36" / 914 mm	44" / 1118 mm
Height	85" / 2159 mm	105" / 2667 mm	120" / 3048 mm
Width	39" / 991 mm	37" / 940 mm	37" / 940 mm
Depth	48" / 1219 mm	53" / 1346 mm	53" / 1346 mm
Deck Space	12 ft ² / 1.2 m ²	12 ft ² / 1.2 m ²	12 ft ² / 1.2 m ²
Weight	1,100 lbs / 499 kg	1,400 lbs / 635 kg	1,600 lbs / 726 kg
Compaction Force	30,000 lbs / 13607 kg	30,000 lbs / 13607 kg	60,000 lbs / 27215 kg
Power Supply	Electric - Explosion & Non-Explosion, Pneumatic, Hydraulic		

Note: All measurements are rounded up to the nearest whole unit or decimal.

Stainless Steel Food Grinders

OEG Enviro-Pak's Stainless Steel Food Grinders process food waste into shreds of 6.3mm or less (less than 1/4" shreds) and can be installed indoors or outdoors.

KEY FEATURES

- 316 STAINLESS STEEL
- NO CAST ALUMINUM USED IN DESIGN
- CUSTOM CAPACITY OPTIONS AVAILABLE
- RESTAURANT FOOD WASTE CAN BE GROUND AND DISCHARGED IN A SEWER SYSTEM REDUCING HANDLING AND DISPOSAL FEES
- SAFETY SWITCH ON LID TO PREVENT INJURY
- UL LISTED COMPONENTS
- MEETS AND EXCEEDS INTERNATIONAL MARPOL 73/78 ANNEX V
- UV LIGHT FOR SANITATION



UNIT	MODEL MPC40
Hopper Capacity	5 gal. / 19 litres
Height	41" / 1041 mm
Width	30" / 762 mm
Depth	25" / 635 mm
Deck Space	5.2 ft ² / 0.5 m ²
Weight	375 lbs / 170 kg
HP	5
Requirements	Electric / ExProof
Load Capacity	300 gallons/hr
Meals per Hour	2800 mph
Discharge Size	2" Camlock
Water Inlet Size	3/4" lockable ball valve

Note: All measurements are rounded up to the nearest whole unit or decimal.

Tuff Gut Food Grinders

KEY FEATURES

- DRIVE MOTOR IS ATTACHED ON THE SIDE AND OUT FROM UNDER THE GRIND CHAMBER, ELIMINATING MOTOR BURNOUTS DUE TO WATER DAMAGE
- STANDARD OFFSET INLET ON ALL UNITS PREVENTS ACCIDENTAL INSERTION OF HANDS AND OTHER OBJECTS
- AUTO REVERSING BLADES IN ALL ELECTRIC MODELS
- 4" DRAIN LINE
- 225 CFM REQUIRED FOR AIR OPERATION
- 5 GALLONS PER MINUTE WATER CONSUMPTION
- SINK HOUSING MATERIAL IS 304 STAINLESS STEEL
- 10" STANDARD ROTOR ON ALL MODELS
- MEETS AND EXCEEDS INTERNATIONAL MARPOL 73/78 ANNEX V
- UV LIGHT FOR SANITATION

OPTIONS

- MAGNETIC SILVERWARE SAVER - MAGNETIC CATCH GUARD AT OPENING OF DISPOSAL AREA - NEVER LOSE SILVERWARE AGAIN
- PUSH ROD IS AN OEM APPROVED TOOL TO ELIMINATE FOREIGN OBJECTS BEING PUT INTO UNIT
- AVAILABLE IN AIR OR ELECTRIC DRIVEN

UNIT	TUFF GUT	MODEL	MEALS PER HOUR
Hopper Capacity	5 gal. / 19 litres	5 HP Electric	2800 mph
Height	36" / 914 mm	7.5 HP Electric	3500 mph
Width	27" / 686 mm	10 HP Electric	4400 mph
Depth	27" / 686 mm	15 HP Electric	5200 mph
Weight	396 lbs / 179 kg	Air Operated	4100 mph
HP	5, 7.5, 10, 15		
Requirements	Electric / Ex-proof, Air		
Load Capacity	300 gallons/hr		

Note: All measurements are rounded up to the nearest whole unit or decimal.

OEG Enviro-Pak's Tuff Gut Food Grinders use a revolutionary TEFC external motor design and are designed to withstand outdoor elements while being silent enough to run indoors. The electric 5hp is housed in an explosion proof enclosure, exceeding Class I division II standards.



Tuff Gut II Food Grinders

KEY FEATURES

- ALL STAINLESS STEEL STRUCTURE AND GRINDING COMPONENTS ENSURING LONG LIFE AND RELIABILITY
- AUTOMATIC OPERATION
- MULTIPLE POWER SUPPLY VOLTAGES
- IP55 PROTECTION CLASS
- HOPPER FLUSHING NOZZLE
- SAFETY SWITCH ON HOPPER LID PREVENTS OPERATION UNLESS LID IS CLOSED
- MEETS AND EXCEEDS INTERNATIONAL MARPOL 73/78 ANNEX V
- UV LIGHT FOR SANITATION

OPTIONS

- 50 OR 60 HZ ELECTRICAL POWER SUPPLY
- CLASS I DIVISION II OR OTHER EX-PROOF CLASSIFICATION
- MAGNETIC SILVERWARE SAVER CATCH GUARD AT OPENING OF DISPOSAL AREA - NEVER LOSE SILVERWARE AGAIN
- RINSE WATER SPOUT
- PUSH ROD IS AN OEM APPROVED TOOL TO ELIMINATE FOREIGN OBJECTS BEING PUT INTO UNIT
- ODOUR ENZ - ENVIRONMENTALLY SAFE ENZYME ODOUR EATER
- CUSTOM SINK SIZES AND MOTORS
- UNDERSINK OR WORKTABLE MODELS

UNIT	5 GALLON SINK	45 GALLON SINK
Hopper Capacity	5 gal. / 19 litres	45 gal. / 170 litres
Height	41" / 1044 mm	62" / 1579 mm
Width	31" / 805 mm	40" / 1019 mm
Depth	26" / 652 mm	41" / 1036 mm
Deck Space	5.6 ft ² / 0.5 m ²	11.4 ft ² / 1 m ²
Weight	350 lbs. / 159 kg	700 lbs. / 318 kg
HP	5, 7.5, 10, 15	10, 15, 20
Requirements	240 or 480 vac / 3 ph / 50 or 60 hz	240 or 480 vac / 3 ph / 50 or 60 hz
Load Capacity	200 gallons / 750 litres / hr	400 gallons / 1500 litres / hr

Note: All measurements are rounded up to the nearest whole unit or decimal.

OEG Enviro-Pak's Tuff Gut II Food Grinders are designed for galley installation, but are suitable to withstand outdoor elements. The Tuff Gut II is delivered ready to connect to the water supply, discharge and power supply for easy setup.



B36 Balers

OEG Enviro-Pak's B36 Balers bale paper, plastic bottles and cardboard with up to 60,000 pounds of compaction force.

KEY FEATURES

- HYDRAULIC BALE EJECT FUNCTION
- DOOR LATCH ENGINEERED FOR GRADUAL RELEASE
- OPTIONAL HEPA FILTRATIONS SYSTEM AVAILABLE
- REDUCE DISPOSAL COSTS BY REDUCING WASTE VOLUME
- MEETS AND EXCEEDS INTERNATIONAL MARPOL 73/78 ANNEX V

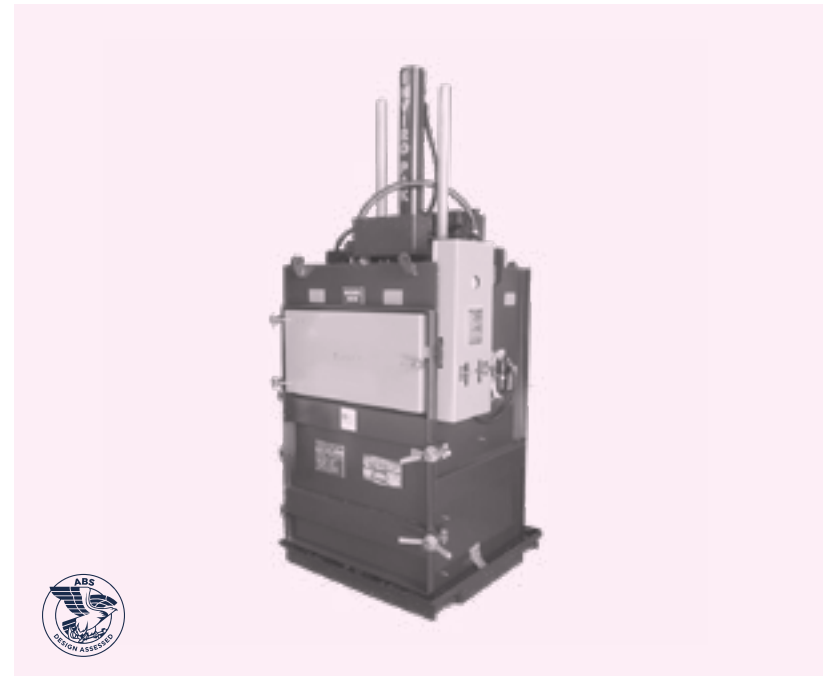

UNIT	MODEL B36
Capacity	36 ft ³ / 1.0 m ³
Height	117" / 2971 mm
Width	51" / 1295 mm
Depth	53" / 1346 mm
Deck Space	19 ft ² / 1.8 m ²
Weight	2,300 lbs / 1043 kg
Compaction Force	60,000 lbs / 27216 kg

Note: All measurements are rounded up to the nearest whole unit or decimal.

Stainless Steel Vertical Balers

The Stainless Steel Vertical Balers are constructed from 316 stainless steel and bale paper, plastic bottles and cardboard.

KEY FEATURES

- COMPONENT PARTS ARE SAND BLASTED AND PAINTED
- DOOR LATCH ENGINEERED FOR GRADUAL RELEASE
- AIR OR ELECTRIC OPERATION
- REDUCE DISPOSAL COSTS BY REDUCING WASTE VOLUME
- TWO HAND OPERATION FOR OPERATOR SAFETY
- COMPACTION/BALE IN BAG CAPABILITIES
- BALE EJECT SYSTEM
- UL LISTED
- MEETS AND EXCEEDS INTERNATIONAL MARPOL 73/78 ANNEX V
- PATENT PENDING

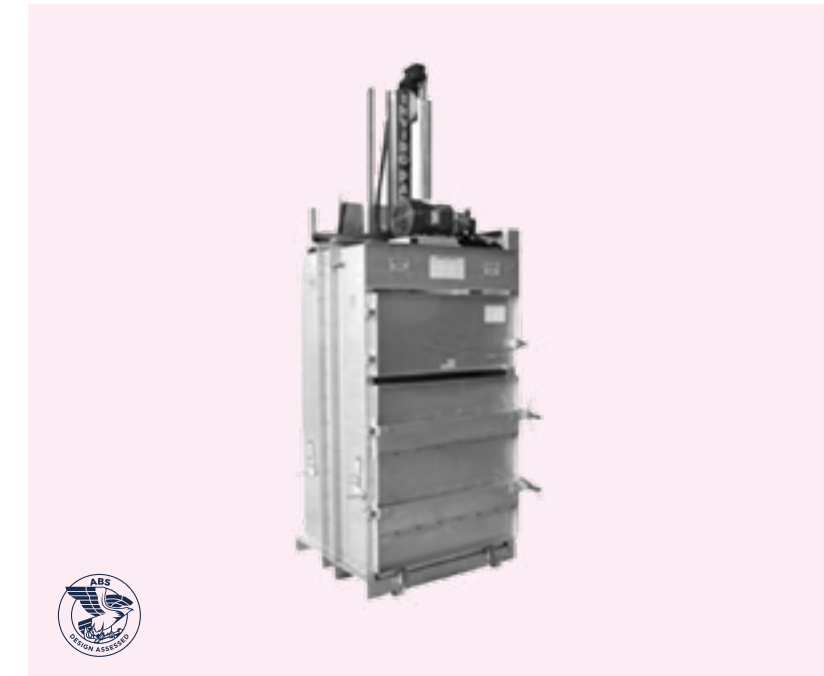

UNIT	MODEL H2	MODEL H5	MODEL H10	MODEL H15
Capacity	6 ft ³ / 0.2 m ³	20 ft ³ / 0.57 m ³	45 ft ³ / 1.2 m ³	58 ft ³ / 1.6 m ³
Height	76" / 1930 mm	89" / 2261 mm	120" / 3048 mm	125" / 3175 mm
Width	32" / 813 mm	46" / 1168 mm	49" / 1245 mm	52" / 1320 mm
Depth	27" / 686 mm	48" / 1219 mm	95" / 2413 mm	58" / 1473 mm
Deck Space	6 ft ² / 0.6 m ²	15 ft ² / 1.4 m ²	19 ft ² / 1.8 m ²	21 ft ² / 2.0 m ²
Weight	520 lbs / 236 kg	1,615 lbs / 733 kg	1,930 lbs / 876 kg	2,100 lbs / 952 kg
Compaction Force	10,000 lbs / 4536 kg	28,000 lbs / 12701 kg	40,000 lbs / 18144 kg	60,000 lbs / 27216 kg
Bag Part Number	HV96033	HV96025	HV96030	HV96027
Bag SWL	650 LBS / 295 KG	1000 LBS / 454 KG	2000 LBS / 907 KG	2200 LBS / 997 KG
Electrical Rating	2HP 110/230/480V 14/5.8/2.9 AMPS	3HP 230/460V 7.8/2.9 AMPS	3HP 230/460V 7.8/2.9 AMP	3HP 230/460V 7.8/2.9 AMP
Air Requirement	100PSI / 75CFM	100PSI / 75CFM	100PSI / 75CFM	100PSI / 75CFM
Cycle Time	35 seconds	50 seconds	95 seconds	95 seconds

Note: All measurements are rounded up to the nearest whole unit or decimal.

Regulated Waste Bags

The Regulated Waste Bag is designed to contain regulated waste from offshore vessels for the required 2-year decontamination period as well as hazardous material waste associated with various on-shore operations.



KEY FEATURES

- UN/DOT HAZARDOUS MATERIAL TRANSPORTER
- WOVEN POLYPROPYLENE COATED FABRIC WITH 150 MICRON INNER LINER
- SELF-RAISING STAND-ALONE TECHNOLOGY: SELF SUPPORTING FIBC AND DOES NOT NEED A STAND OR BAG HOLDER
- 3000 LBS WORK LOAD WITH A 5:1 SAFETY FACTOR
- FOLD UP DESIGN FOR CONVENIENCE WHEN BAGS NOT IN USE
- OPTIONAL BARCODE TRACKING

HAZARDOUS WASTE APPLICATIONS

- CONTAMINATED FOOD PACKAGING
- OIL FILTERS
- ABRASIVE BLASTING MEDIA
- PAINT CANS
- OIL RAGS

BAG MODEL / PART #	CAPACITY	SAFE WORKING LOAD	PALLET QUANTITY	DIMENSIONS
HV96036	30ft ³ / 0.85m ³	3000 lbs / 1384 kg	40	36" X 36" X 36"

Note: All measurements are rounded up to the nearest whole unit or decimal.

30% Recycled Compactor Bags

OEG Enviro-Pak's new 30% recycled polypropylene offshore waste/ compactor bags are a step forward in maximizing our recycling and waste reduction efforts, while providing our customers with sustainable waste handling solutions.



KEY FEATURES

- PRODUCED USING BIODEGRADABLE 30% RECYCLED POLYPROPYLENE TO REDUCE POLYPROPYLENE CONSUMPTION
- BAGS MANUFACTURED TO A 5:1 SAFETY RATIO
- BAGS ARE AVAILABLE FOR ALL COMPACTOR MODELS
- FOLD UP DESIGN FOR CONVENIENCE WHEN BAGS NOT IN USE
- BAGS TESTED TO 5X RATED LOAD
- BAG STANDS AVAILABLE FOR MODEL 1200, 1400, 2000, 3000, 4000, AND 5000 BAGS

BAG MODEL	PART NUMBER	COMPACTOR MODEL	CAPACITY	SAFE WORKING LOAD	PALLET QUANTITY
5000 / B-5000-01-07-W5	HV96027	5000, MG15, H15	50 ft ³ / 1.4 m ³	2,200 lbs / 1000 kg	175
5000 Green / B-5000-01-07-G5	HV96031	5000, MG15, H15	50 ft ³ / 1.4 m ³	2,200 lbs / 1000 kg	150
4000 / B-4000-01-07-W4.5	HV96030	4000, MG10, H10, 40M	40 ft ³ / 1.1 m ³	2,000 lbs / 907 kg	200
4000 Green / B-4000-01-07-G4.5	HV96029	4000, MG10, H10, 40M	40 ft ³ / 1.1 m ³	2,000 lbs / 907 kg	175
3000 / B-3000-01-07-W4.5	HV96026	3000	30 ft ³ / 0.85 m ³	1,500 lbs / 685 kg	250
2000 / B-20M-01-07-W3.5	HV96025	H5, 20M	20 ft ³ / 0.6 m ³	600 lbs / 272 kg	300
1700 / B-1700-01-07-W4	HV96024	MG5, 1700	17 ft ³ / 0.5 m ³	600 lbs / 272 kg	400
1400 / B-1400-01-07-W5	HV96023	1400, R6×2	14 ft ³ / 0.4 m ³	550 lbs / 250 kg	450
1400 Green / B-1400-01-07-G5	HV96022	1400, R6×2	14 ft ³ / 0.4 m ³	550 lbs / 250 kg	450
1200 / B-1200-01-07-W5	HV96021	1200	12 ft ³ / 0.3 m ³	600 lbs / 272 kg	375
600 / B-600-01-07-W3	HV96033	MG2, H2, 600	6 ft ³ / 0.2 m ³	650 lbs / 295 kg	600
TRI2 Green / B-TRI2-01-07-G5	HV96035	R6, R6×2	5.5 ft ³ / 0.16 m ³	600 lbs / 272 kg	500
R44 Green / B-R44-01-07-G4	HV96034	R44	3.5 ft ³ / 0.1 m ³	350 lbs / 159 kg	800
Universal Red Strap / B-345K-RED	HV96027	30/40/50	50 ft ³ / 1.4 m ³	2,200 lbs / 1000 kg	175
Universal White Strap / B-345K-WHITE	HV96028	30/40/50	50 ft ³ / 1.4 m ³	4,000 lbs / 1814 kg	150

Note: All measurements are rounded up to the nearest whole unit or decimal.

Recycle the Gulf®



Protecting the environment.

Enhancing corporate responsibility.

Supporting local communities.

About the program

OEG Offshore's Recycle the Gulf is an environmental program designed to reduce and recycle waste generated offshore in the Gulf of Mexico. Utilizing OEG's Enviro-Pak waste compactor product line, recyclables can be collected, sorted and compacted on the rig.

All recyclables are donated to a Louisiana-based partner, The Arc of Acadiana, an organization dedicated to improving the lives of people with developmental disabilities.



How Recycle the Gulf® works

Our environmental program provides many benefits for participating companies and OEG makes it simple to take part.

- OEG'S ENVIRO-PAK COMPACTORS ARE AVAILABLE FOR RENT OR PURCHASE TO RIGS OPERATING IN THE GULF OF MEXICO
- RECYCLABLES ARE SORTED AND COMPACTED ON THE RIG, THEN SHIPPED IN ECO-FRIENDLY BAGS TO THE RIG'S DOCK FACILITY
- SPECIALTY CONTAINERS LABELED 'RECYCLED WASTE ONLY' LOCATED AT THE RIG'S DOCK FACILITY STORE INCOMING ECO-FRIENDLY BAGS OF RECYCLABLES FROM EACH PARTICIPATING RIG
- OEG MANAGES THE LOGISTICS OF COLLECTING AND EXCHANGING THE BAGS, AS WELL AS DELIVERING THEM TO THE ARC OF ACADIANA
- CONTRIBUTIONS ARE ACCOUNTED FOR BY COMPANY AND MONTHLY REPORTS ARE POSTED TO AN ONLINE CUSTOMER PORTAL
- THE ARC OF ACADIANA EMPLOYEES GRADE THE RECYCLE MATERIALS
- ALL REVENUE FROM RECYCLED MATERIALS IS DONATED TO THE ARC OF ACADIANA

Benefits of the program

Participating in the program assists companies with MARPOL 73/78 and ISO 14001 compliance and allows socially responsible companies to build a positive reputation and increase financial performance.

To date, Recycle the Gulf program participants have recycled 12+ million pounds of offshore waste in our EPA Gulf Guardian Award winning program (2004).

An environmentally conscious supply chain is valued and recognized by stakeholders now more than ever; the program allows companies to enhance their corporate responsibility.

The program supports the local community by generating revenue for The Arc of Acadiana, while providing disabled individuals with jobs and purpose.

Offshore waste is sorted by recycling center employees who separate and repackage recyclables. Recyclables are then sold, providing revenue for The Arc of Acadiana.

Ontime, anytime, anywhere

We bring the best of size
and scale, combined with
bespoke solutions

North America

Canada
Mexico
USA

South America

Brazil
Guyana
Suriname
Trinidad

UK & Europe

Denmark
Germany
Italy
Netherlands
Norway
Romania
United Kingdom

Africa

Angola
Congo
Gabon
Ghana
Nigeria
Republic of the Congo
Senegal

Caspian

Azerbaijan
Kazakhstan

Middle East

Qatar
Saudi Arabia
United Arab Emirates

Asia Pacific

Australia
Brunei
China
Malaysia
New Zealand
Singapore
Taiwan
Thailand
Vietnam

Australia & New Zealand

Australia
New Zealand

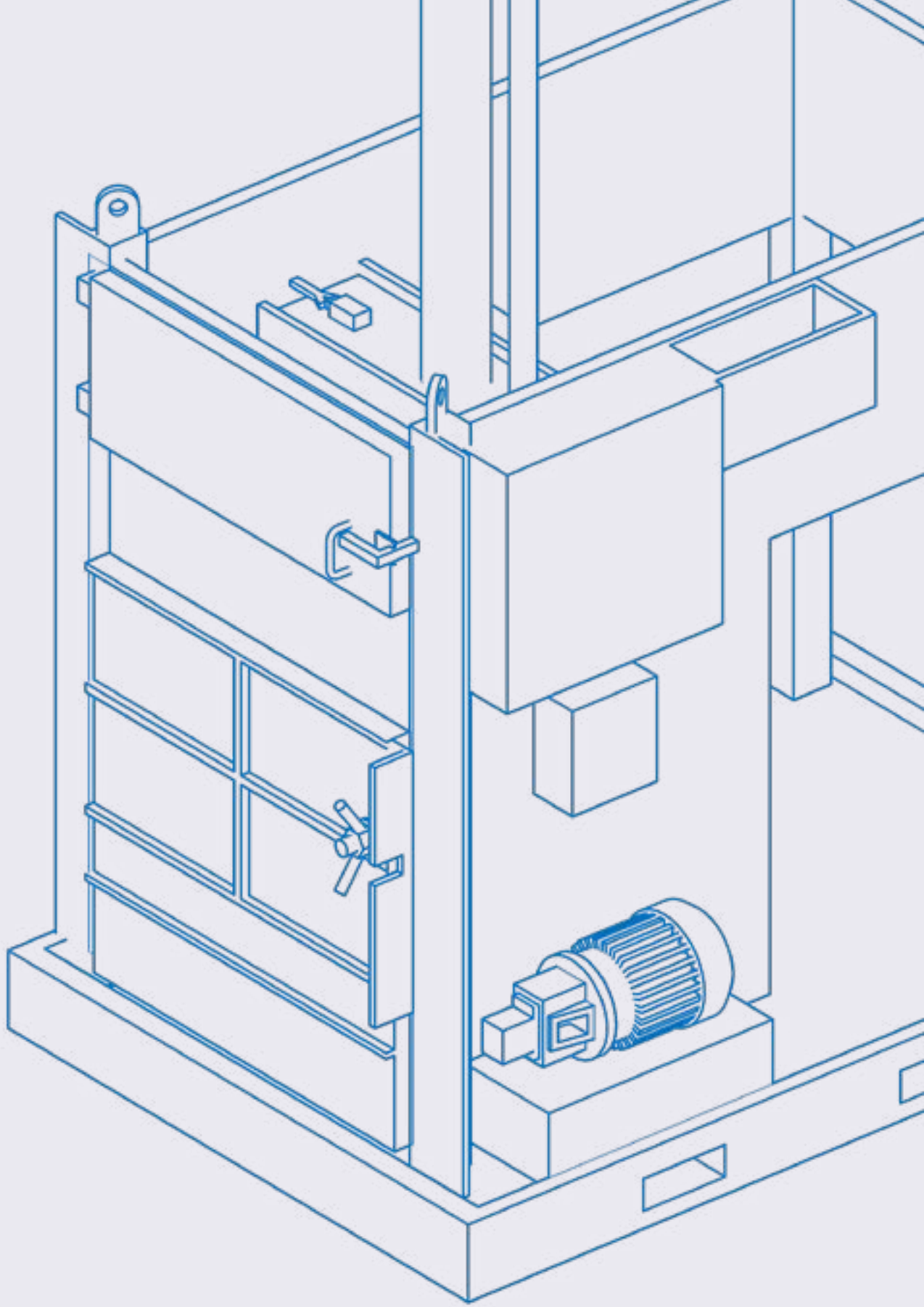

Enviro-Pak

oegoffshore.com
enviropak.sales@oegoffshore.com